

Конвейерные ленты для крутонаклонных конвейеров элеваторного типа

Serie bordi

Волнистая ограждающая кромка (гофроборт)

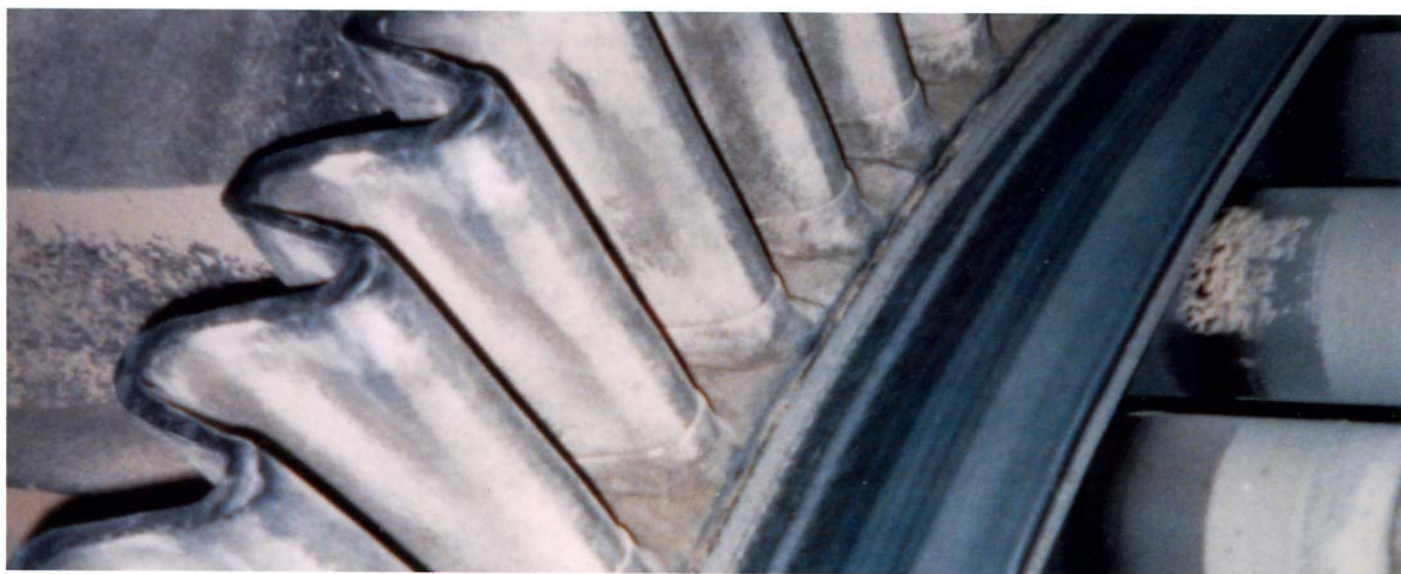
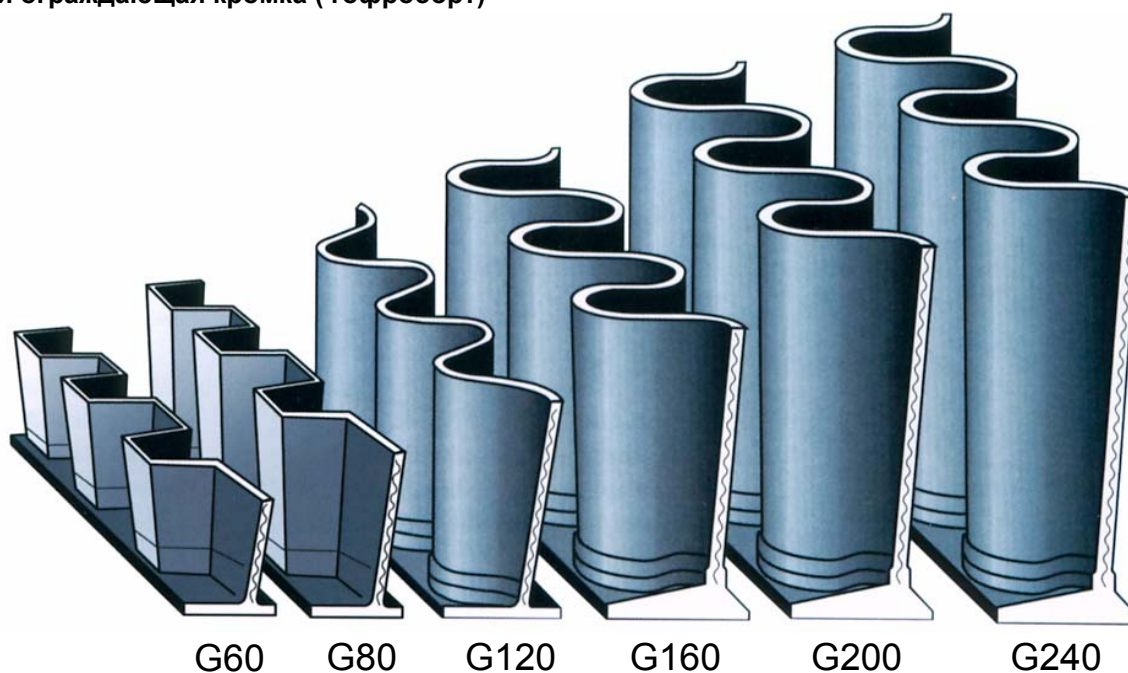

Значение	G60	G80	G120	G160	G200	G240
a	60	50	60	80	80	80
b	60	80	120	160	200	240
c	55	50	60	80	80	80
p (min)	75	75	100	100	100	120
Вес 1 м.п.	1,5	1,8	2,2	4,5	7,5	10 Кг/м

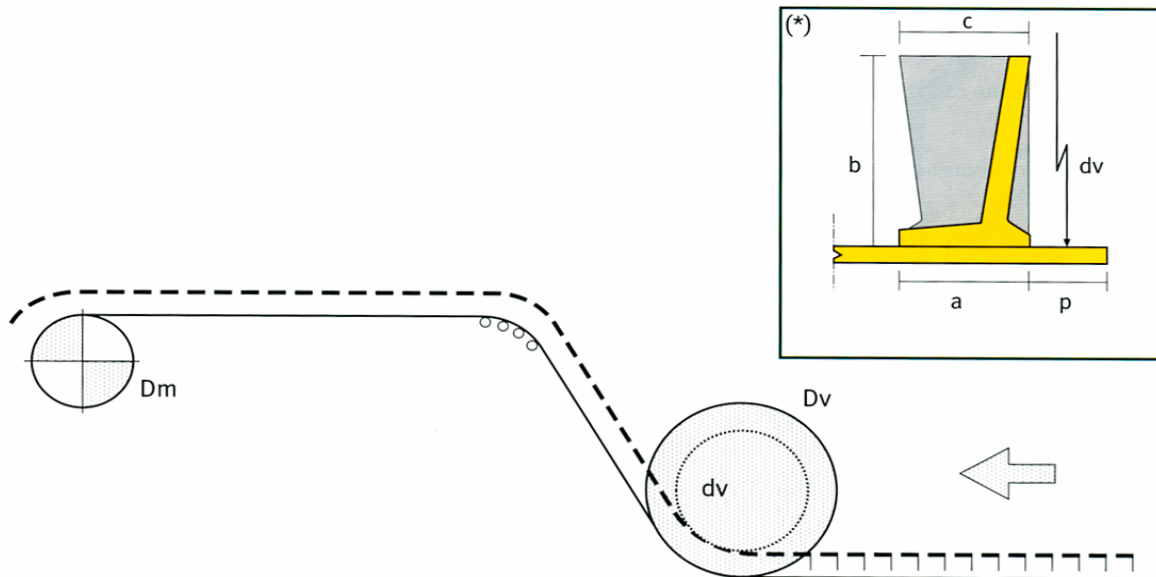

Рекомендуемые диаметры барабанов

	G60	G80	G120	G160	G200	G240
Dm (min)	160	200	315	350	450	630
Dv (min)	300	350	500	600	700	800
dv (min)	180	190	260	280	300	320



G60, G80



G 120 - G240

Serie traverse

Захваты (поперечные ребра)

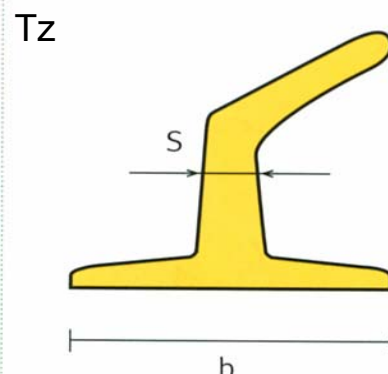
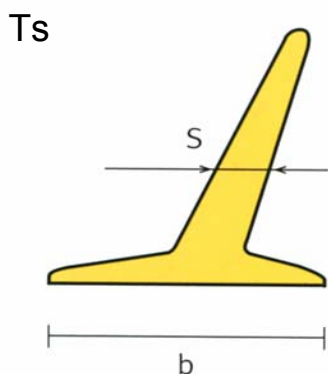
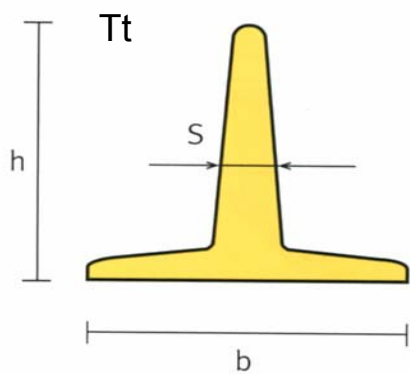

Значение	Tt 50	Ts 70	Ts 110	Tz 110	Tz 140	Tz 180	Tz 220
h	50	70	110	110	140	180	220
b	70	80	110	105	150	160	170
s	8	10	12	20	15	20	20
Вес 1 м.п.	1	1,4	2,9	4,5	5,5	9,5	13
							Kr/m

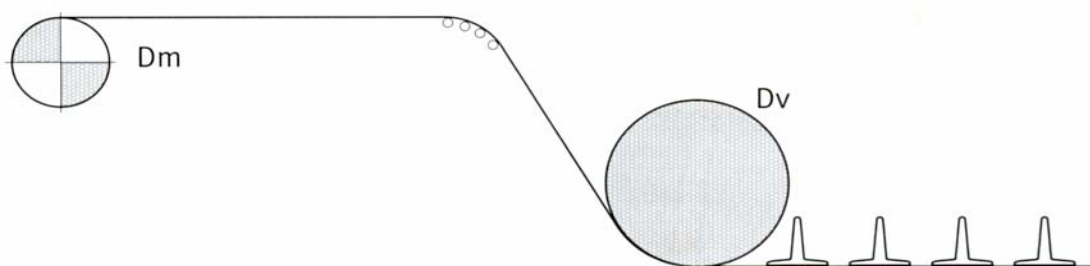

	Tt 50	Ts 70	Ts 110	Tz 110	Tz 140	Tz 180	Tz 220
Dm (min)	160	200	350	350	375	500	630
Dv (min)	250	300	450	450	550	800	800